

E.W. MORRIS

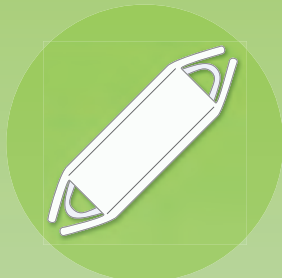

Expanding Frame Tags

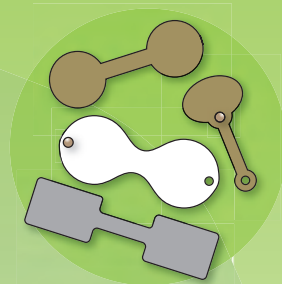

Dumbbells & Button Tags



Dummy Lens Labels



Presentation Trays



Price Tickets



Packaging



Display Accessories

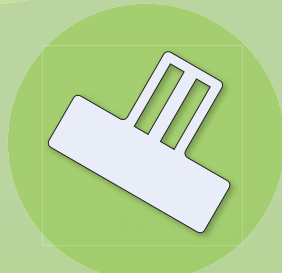

Slide on Carriers



Price Cubes

Retail Optician

Point of Sale Catalogue

Email orders to sales@ewmorris.co.uk or order online at www.ewmorris.co.uk



Printed Price and Sale Tickets

Vinyl tickets with peelable adhesive. Minimum order quantity of 5 sheets of the same style.

Price tickets are available with any price point, we will reduce the font size to suit where necessary.

£79 OV1B Black on Clear 30 Tickets per sheet	€55 OV1W White on Clear 30 Tickets per sheet	£135 OV2B Black on White 30 Tickets per sheet	+1.00 OV2B Black on White 30 Tickets per sheet	£79 <small>COMPLETE PRICE</small> OV3B Black on Clear 30 Tickets per sheet	30% OFF OV4 Black on Clear 30 Tickets per sheet
30% OFF OV4R Red on White 30 Tickets per sheet	30% OFF OV4RC Red on Clear 30 Tickets per sheet	£79 <small>FRAME ONLY</small> OV5 Black on Clear 30 Tickets per sheet	£58 OV6 Red on Clear 30 Tickets per sheet	£99 OV7 Green on Clear 30 Tickets per sheet	€55 OV8 Blue on Clear 30 Tickets per sheet
£58 OV9 Red on White 30 Tickets per sheet	£99 OV10 Green on White 30 Tickets per sheet	€55 OV11 Blue on White 30 Tickets per sheet	£249 <small>SALE PRICE</small> OV40 Black on Clear 30 Tickets per sheet	£299 <small>SALE PRICE</small> OV41 Red on Clear 30 Tickets per sheet	£69 <small>SALE PRICE</small> OV42 Black on White 30 Tickets per sheet
£49 <small>SALE PRICE</small> OV43 Red on White 30 Tickets per sheet	£165 <small>Includes single vision lenses</small> SV1 Black on Clear 30 Tickets per sheet	£65 <small>Includes single vision lenses</small> SV1R Red Price, Black text on Clear 30 Tickets per sheet	£129 <small>Your own wording</small> OV31 Black on Clear 30 Tickets per sheet	£129 <small>Your own wording</small> OV32 Black on White 30 Tickets per sheet	Was £129 Now £99 OV33 Red on White 30 Tickets per sheet
£235 <small>SALE PRICE</small> OV34 Black on White 30 Tickets per sheet	£549 <small>SALE PRICE</small> OV35 Red on White 30 Tickets per sheet	£129 <small>Your own wording</small> OV36 Red on Clear 30 Tickets per sheet	£129 <small>Your own wording</small> OV37 Red on White 30 Tickets per sheet	£139 CIRC Black on Clear 30 Tickets per sheet	£165 <small>Your own wording</small> CIRC TEXT Black on Clear, 30 Tickets per sheet
£145.00 TP3CB Black on Clear 30 Tickets per sheet	€159.99 TP3CW White on Clear 30 Tickets per sheet	YOUR TEXT TP3TEXT Black on Clear 30 Tickets per sheet	DISPLAY ONLY TP3DO Black on Clear 30 Tickets per sheet		

Coloured Paper and White Card tickets with permanent adhesive.

Minimum order quantity of 5 sheets of the same style.

£58 OV12 Black on Orange 30 Tickets per sheet	\$95 OV13 Black on Red 30 Tickets per sheet	€55 OV14 Black on Light Blue 30 Tickets per sheet	£100 OV15 Black on Pink 30 Tickets per sheet	£225 OV16 Black on Yellow 30 Tickets per sheet
89.- OV17 Black on Beige 30 Tickets per sheet	\$195 OV18 Black on Gold 30 Tickets per sheet	€125 OV19 Black on Silver 30 Tickets per sheet	£59 OV20 Black on Green 30 Tickets per sheet	£XX with SV LENSES SV2 Black on Orange 30 Tickets per sheet
£149.00 TP3 Black on White Card 28 Tickets per sheet	£100.00 TP3S Black on Silver 28 Tickets per sheet	£100.00 TP3G Black on Gold 28 Tickets per sheet	£24.00 S4BW Black on White Card 20 Tickets per sheet	£75.00 S4BS Black on Silver 20 Tickets per sheet
				£99.99 S4BG Black on Gold 20 Tickets per sheet

Labels shown actual size, small ovals are 15mm x 8mm, large ovals are 20mm x 12mm, circle is 13mm diameter, TP3 labels are 18mm x 5mm and S4 labels are 19mm x 5mm

Children's fun reward stickers. 30mm diameter, supplied in small dispenser boxes of 250 labels. White paper with permanent adhesive, suitable for most clothing.



OP Labels for Dummy Lenses

These labels are printed on gloss self adhesive vinyl. Sold in quantities of 250 and packaged in our handy dispenser boxes.

10% off Marked Price OP33	15% off Marked Price OP34	20% off Marked Price OP35	25% off Marked Price OP1	30% off Marked Price OP36	35% off Marked Price OP37	40% off Marked Price OP38
50% off Marked Price OP2	50% off Marked Price OP11	60% off Marked Price OP39	70% off Marked Price OP40	75% off Marked Price OP46	FREE Second Pair OP3	FREE 2nd Frame OP54
FREE FRAMES & Lenses for Kids OP4	FREE FRAMES & Lenses for Kids OP31	FREE with NHS Voucher OP5	FREE with NHS Voucher OP12	FREE with NHS Voucher OP32	2nd Pair Half Price OP103	NEW OP7
£10 with NHS Voucher OP9	£10 with NHS Voucher OP13	£15 with NHS Voucher OP43	£19 with NHS Voucher OP61	£20 with NHS Voucher OP14		
£25 with NHS Voucher OP44	£29 with NHS Voucher OP62	£30 with NHS Voucher OP15	£39 with NHS Voucher OP63			
£40 with NHS Voucher OP27	£45 with NHS Voucher OP56	£49 with NHS Voucher OP64	£50 with NHS Voucher OP28			
£59 with NHS Voucher OP65	£60 with NHS Voucher OP29	£69 with NHS Voucher OP66	£70 with NHS Voucher OP30			
£79 with NHS Voucher OP67	£89 with NHS Voucher OP68	£99 with NHS Voucher OP69	FREE Sunglasses OP20	2 FOR 1 OP26	FREE with Voucher OP16	2 FOR 1 OP45
				€10 with Voucher OP17	€20 with Voucher OP18	€30 with Voucher OP19
				€50 with Voucher OP70	Prescription Lenses Fitted OP24	Kids Go Free OP25
				SALE OP6	SALE OP41	SALE OP60

Price includes frames & lenses
OP122

OP Labels for Dummy Lenses continued



Self Cling Labels for Dummy Lenses

These labels are printed on gloss static cling material. All designs available in our OP range are now available in a self cling option and can be specified by changing the OP code to CL. e.g. OP1 becomes CL1. Sold in quantities of 50 labels. We can produce these to your own design - please contact us for details.

A few examples:



TIRO & Contact Lens Packaging Labels

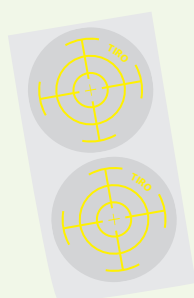

TIRO Varifocals pupil centration labels

With 6mm, 12mm, 18mm, and centre markings. Printed in yellow onto clear peelable vinyl and supplied in handy dispenser boxes of 250 labels.

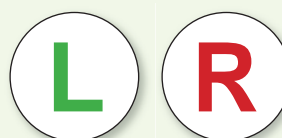

LR1 Contact lens packaging labels

Printed on ultra peelable laminated paper. Sold in quantities of 500 (250 of each) and packaged in our handy dispenser boxes. Available in other languages to special order.

Price Cubes

Mini-relief (Lansa) 3 x 5mm price cubes

White/black, white/gold, black/white, clear/black, clear/blue, white/blue or black/gold (cube/figure).

- 3150 - Set of 260
- 31000 - Set of 640
- 3110 - 20 of one symbol
- 31700 - 100 of one symbol



Norma (Lansa) 5 x 6mm price cubes

White/black, black/white, black/gold, clear/black negative, clear/blue negative or clear/black (cube/figure).

- 4250 - Set of 260
- 41000 - Set of 640
- 4210 - 20 of one symbol
- 41700 - 100 of one symbol



Norma (Lansa) fluo 5 x 6mm transparent price cubes

Yellow/black, orange/white, red/white, violet/white, green/white or blue/white (cube/figure).

- 44050 - Set of 260
- 44000 - Set of 640
- 4410 - 20 of one symbol
- 44020 - 100 of one symbol



Medium (Lansa) 7 x 9mm price cubes

White/black, black/white, grey/white, clear/black negative, clear/blue negative or clear/black (cube/figure).

- 6450 - Set of 260
- 61000 - Set of 640
- 6410 - 20 of one symbol
- 61700 - 100 of one symbol



A Lansa price cube set contains:

	1	2	3	4	5	6	7	8	9	0	00/-
260 pieces	25	15	15	15	25	15	15	15	25	35	60
640 pieces	60	40	40	40	60	40	40	40	60	100	120

Individual symbols available: £ € \$. - 0 1 2 3 4 5 6 7 8 9 + various end cubes.

Medium (Lansa) fluo 7 x 9mm transparent price cubes

Yellow/black, orange/white, red/white, violet/white or blue/white (cube/figure).

- 65050 - Set of 260
- 65000 - Set of 640
- 6510 - 20 of one symbol
- 65020 - 100 of one symbol



Super (Lansa) 10 x 12mm price cubes

White/black or black/white (cube/figure).

- 7550 - Set of 260
- 71000 - Set of 640
- 7510 - 20 of one symbol
- 71700 - 100 of one symbol



Prestige De Luxe (Lansa) Mini 6mm price cubes

Available in gold or silver.

- 12550 - Set of 260
- 12000 - Set of 640
- 12510 - 20 of one symbol
- 12700 - 100 of one symbol



Prestige De Luxe (Lansa) Standard 8mm price cubes

Available in gold or silver.

- 10550 - Set of 260
- 11000 - Set of 640
- 10510 - 20 of one symbol
- 11700 - 100 of one symbol



Prestige De Luxe (Lansa) Maxi 14mm price cubes

Available in gold or silver.

- 14550 - Set of 260
- 14010 - 20 of one symbol
- 14700 - 100 of one symbol



Mini-relief, Norma, Medium, Super & Prestige sets are available with 00 or .- Please specify symbol needed when ordering. None of these cube sets have a currency symbol included - these must be ordered separately.

Nova small 3 x 5mm price cubes

Black/white or clear/black (cube/figure).

- 242105 - Set of 280
- 242110 - Set of 700
- 242115 - 20 of one symbol
- 242120 - 100 of one symbol



A Nova price cube set contains:

	1	2	3	4	5	6	7	8	9	0	00	£	.
280 pieces	20	20	20	20	20	20	20	20	20	40	20	20	20
700 pieces	50	50	50	50	50	50	50	50	50	100	50	50	50

Alphabet (Lansa) cubes

White/black or black/white (cube/figure).

- Mini-relief 3155 - Set of 260
- Norma 4255 - Set of 260
- Medium 6455 - Set of 260
- Super 7555 - Set of 260



Alphabet (Lansa) price cube set contains:

A	B	C	D	E	F	G	H	I	J	K	L	M	N	O	P	Q	R	S	T	U	V	W	X	Y	Z	BLANK SPACE	BLANK END
16	8	8	10	15	8	10	8	18	6	6	8	6	14	13	8	6	14	14	14	8	6	6	2	4	4	10	10

Nova medium 4 x 6mm price cubes

Black/white, black/gold, clear/black or red/white (cube/figure).

- 242125 - Set of 280
- 242130 - Set of 700
- 242135 - 20 of one symbol
- 242140 - 100 of one symbol



Nova large 6 x 9mm price cubes

Black/white or clear/black (cube/figure).

- 242145 - Set of 280
- 242150 - Set of 700
- 242155 - 20 of one symbol
- 242160 - 100 of one symbol



Slide on Label Carriers

Expanding plastic frame tag

53mm x 15mm. Ideal for irregular shaped spectacle arms, suitable for use with our adhesive labels.
 White, crystal and black available in packs of 250's, 500's, 750's and 1,000's
All other colours supplied in 1,000's only.

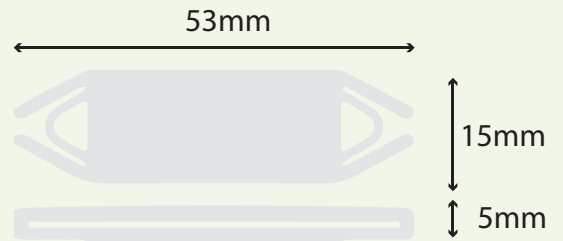

Crystal recycled option made from recycled and recyclable media biosourced from sugar cane. Sold in 1,000's



OPT131, an adjustable plastic frame tag 55mm x 20mm Ideal for irregular shaped frame arms, suitable for use with our **OPT131L** labels

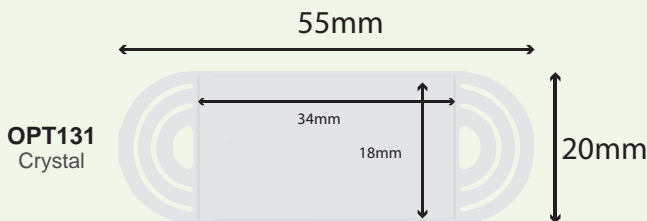

Available in packs of 250, 500, 750 or 1,000

OPT131L Labels for **OPT131**. These can be printed to your requirements on clear self adhesive material.

Available with the following print colours: black, red, blue, green and white. 20 labels per sheet, minimum order of 5 sheets per style. Label size 30mm x 14mm. A few examples:

<p>WAS £199 NOW £149 SPECIAL OFFER</p>	<p>Your Name Here £129.00 Free second pair</p>	<p>Your Name Here £99.00 with NHS voucher</p>	<p>£149 COMPLETE WITH SINGLE VISION LENSES</p>	<p>Your Name Here £199.00 SPECIAL OFFER</p>
--	--	---	---	---

Expanding plastic label carriers

53mm x 18mm. Ideal for the more irregular shaped or wider armed frames. Available in 4 finishes, crystal, white, green and violet. Labels can be fixed to either face. Available in packs of 250, 500, 750 or 1,000. Green and violet supplied in 1000s only.

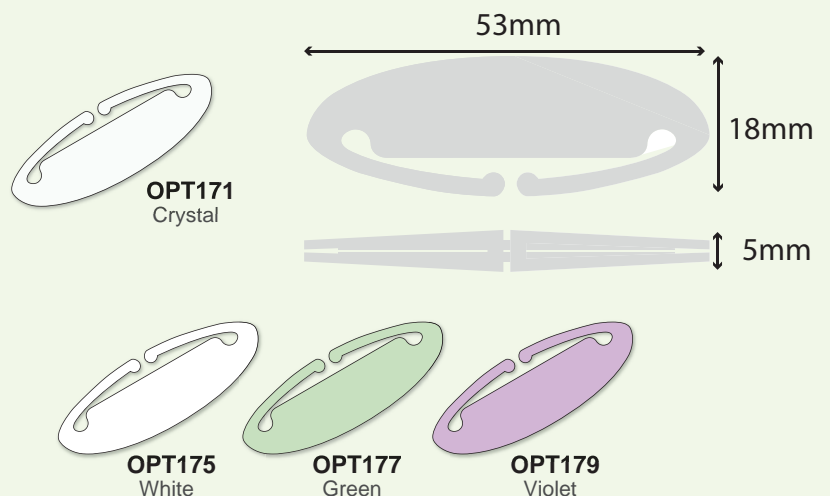

Slide on Label Carriers

Single piece reusable plastic label carriers, suitable for use with our self adhesive price labels. Crystal carriers are available in packs of 250, 500, 750 and 1,000.

All other colours are in packs of 1,000 only.

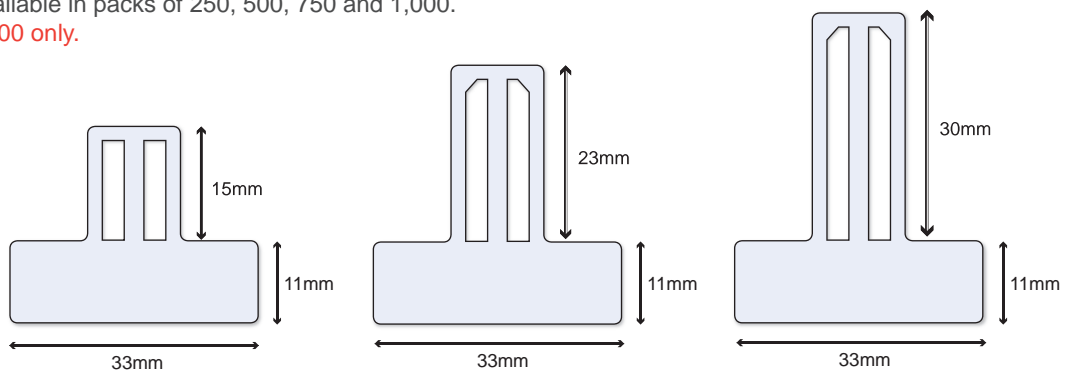

OPT101	OPT102	OPT103	OPT104	OPT105	OPT106	OPT107	OPT108	OPT109	OPT110	OPT1150	OPT1151	OPT116	OPT117	OPT118
OPT121	OPT122	OPT123	n/a	n/a	n/a	n/a	n/a	OPT129	OPT120	OPT1250	OPT1251	OPT126	OPT127	OPT128
Crystal	Gold	Brown	Dark Blue	Red	Grey	Purple	Green	Violet	Aqua	Pink	Lt. Blue	Raspberry	Anise	Mid Blue

Key: 15mm arms 23/30mm arms

Please add A after code to denote 30mm arms, eg **OPT121** is Crystal with 23mm arms and **OPT121A** is Crystal with 30mm arms.

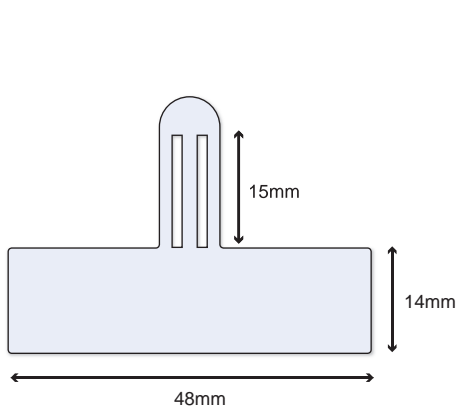

OPT161

Single piece plastic label carrier for longer labels. Available in 1,000's. Crystal only.

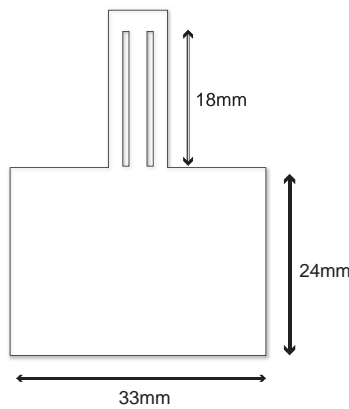

OPT181

Single piece plastic label carrier for larger labels. Available in 1,000's. White only.

OPT181L Labels for OPT181

Printed to your requirements on white self adhesive polypropylene. Available printed in the following colours, black, red, green and blue. 20 labels per strip. Minimum order 5 strips of any one style. Label size 30mm x 21mm. A few examples:

YOUR NAME

£299

ASK ABOUT OUR 0% PAYMENT PLAN

Summer Sale

£99.00

with NHS voucher

Your Name Here

Personalised

£225

PART OF OUR 2 FOR 1 RANGE, INCLUDING SUNGLASSES

Back to School

WAS £129

NOW £99

with NHS voucher

OPT181L1000

A reel of 1,000 self adhesive white polypropylene labels suitable for thermal transfer overprinting. Label size 30mm x 21mm and suitable for applying to our OPT181 label carriers. Supplied on a 35mm wide web, labels outside, wide edge leading on 25mm or 76mm diameter cores.



RMOPT20

Strips of 20 labels printed black on self adhesive white polypropylene. Label size 30mm x 8mm and suitable for applying to many of our popular label carriers. Minimum order 5 strips.

RMOPT1000

A reel of 1,000 white self adhesive polypropylene labels suitable for thermal transfer overprinting. Label size 30mm x 8mm and suitable for applying to many of our popular label carriers. Supplied on a 35mm wide web, labels outside, wide edge leading on 25mm or 76mm diameter cores.

Don't forget we can manufacture and supply a wide range of white and coloured labels suitable for thermal transfer overprinting. Please contact us with your requirements.

Slide on Label Carriers

Two-part plastic label carriers

Reusable plastic label carriers and fixing arms, suitable for use with many of our self adhesive labels. The transparent fixing arms are available in four sizes and will fit any label carrier. The label carriers are available in three sizes in white, black, red, blue, and grey. The fixing arm slides through the label carrier and the label carrier then 'hangs' off the bottom. All elements are available in packs of 250, 500, 750 or 1,000.

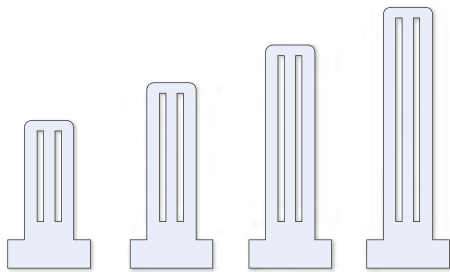

Fixing arms
12mm | 17mm | 22mm | 27mm
87010 | 87020 | 87030 | 87040



Label carrier **87110**
22mm x 14mm



Label carrier **87100**
36mm x 13mm



Label carrier **87160**
45mm x 14mm

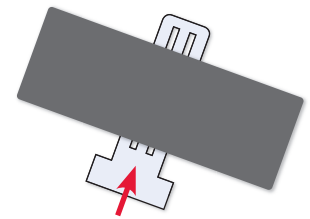
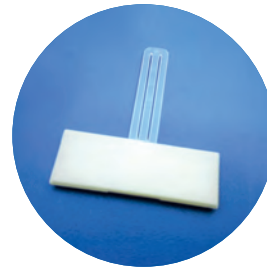
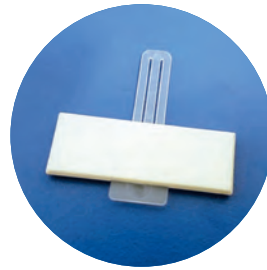
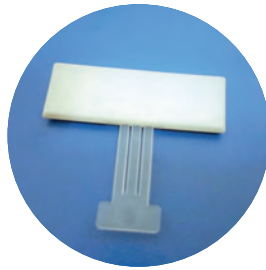
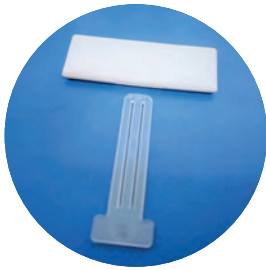

Slip-on plastic frame tags

Packed in 250's, 500's or 1,000's and available in white, gold, or silver. All shown actual size. (Also available to special order in frosted clear, red, yellow, green, mid blue and black.)

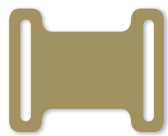

SO801



SO808



SO820



SO833



SO830



Dumbbells and Button Tags

Plastic button tags

Bagged in 250's, 500's or 1,000's. Available in gold, silver or white.
Also available to special order, frosted clear, red, yellow, green, mid blue and black.

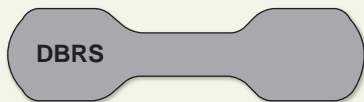
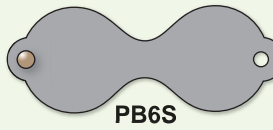
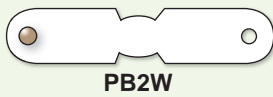
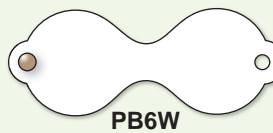
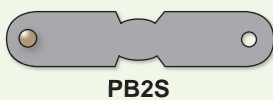
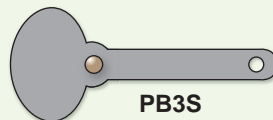
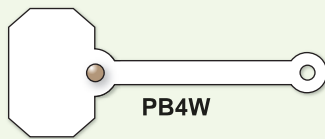
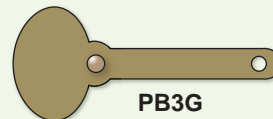
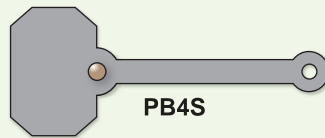
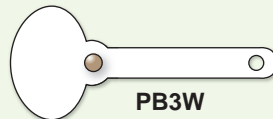
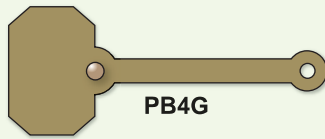
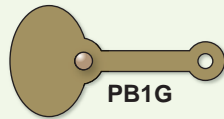
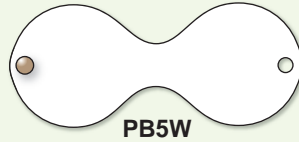
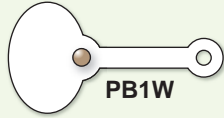
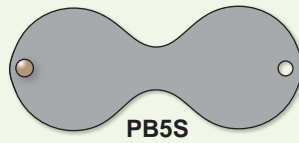
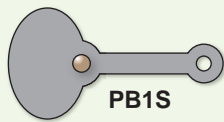

46mm x 11.5mm

Self adhesive paper dumbbells on rolls

Per 1,000 in dispenser boxes.
Centre free of adhesive.

Self adhesive vinyl dumbbells on rolls

Supplied in dispenser boxes of 1,000. Available in gold, silver, yellow, light blue, green, orange, white and red.



Self adhesive coloured circular labels

8mm diameter, boxed in 250's.
Available in yellow, green, dark blue, light blue, gold, silver, red, orange, black and white.

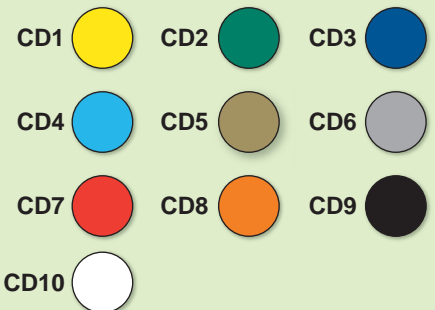

Scriber and Fine Black pens

P440/01 Scriber Pen for scratch on tickets.
P440/02 Black Fine Pen for plastic and vinyl tickets.



Dumbbells and Button Tags

Self adhesive rip proof dumbbells in sheet form

DB1, DB2 and DB9 available in gold, silver or white in packs of 1,000. **DB4** available in white only and in packs of 500. Centre free of adhesive. Supplied with a free fabric marker pen.

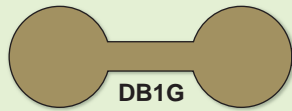

DB1G

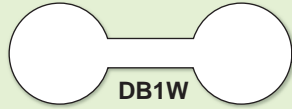

DB1W

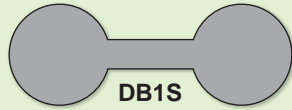

DB1S

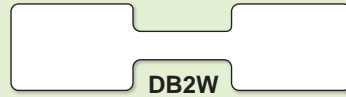

DB2W

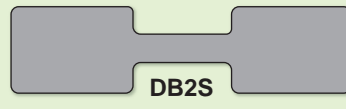

DB2S



DB2G

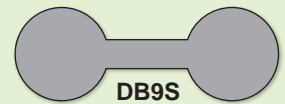

DB9S



DB9G

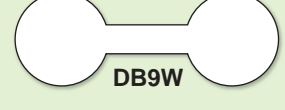

DB9W

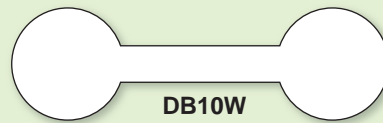

DB10W

Self adhesive rip proof dumbbells on rolls of 1,000

Available in gold, silver or white. Centre free of adhesive.

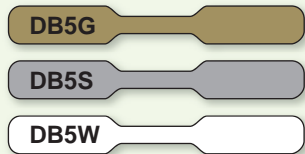

DB5G

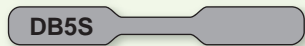

DB5S



DB5W

39mm x 5mm

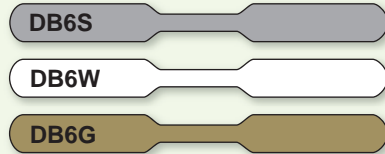

DB6S



DB6W



DB6G

51mm x 5mm



DB7W

39mm x 5mm

String tags

Self adhesive rip proof paper. Available in gold (**DB8G**), silver (**DB8S**) and white (**DB8W**). Supplied with a free fabric marker pen. Packed in 500's.



Simulated security anti-theft tags. Rolls of 500 labels

Create the impression that the tags must be de-magnetised.

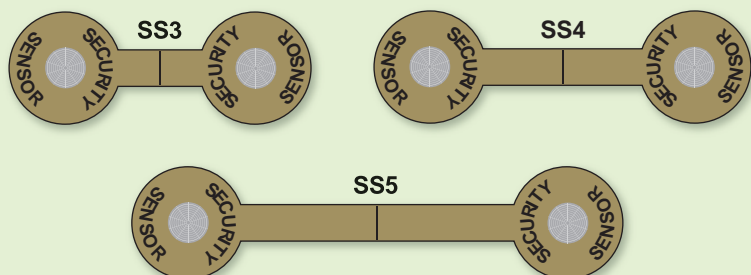

Packaging



Silver & black carrier bags

Polythene carrier bags. Packed in 100's. Available in two sizes:

- 3334** 145mm x 230mm
- 3335** 220mm x 370mm

Cellobags with side gussets

Suitable for A5 or A6 record cards, supplied in packs of 1,000.

- CEL001** A6 105mm x 150mm 20mm gusset
- CEL002** A5 150mm x 213mm 20mm gusset



CEL001

CEL002

Classic Gloss Plastic Carrier Bags

Handy-sized plastic bags in an attractive gloss gold, gloss burgundy or gloss black. Low density polythene adds a feeling of quality and provides good opacity. Reinforced patch handles for comfort and strength. Made with up to 30% recycled content for an eco-friendly packaging solution.

Available sizes 250mm x 300mm x 60mm & 390mm x 450mm x 100mm. Packed in 100's

- GPC84765** Gold 250mm x 300mm x 60mm
- GPC84768** Gold 390mm x 450mm x 100mm
- GPC85133** Silver 250mm x 300mm x 60mm
- GPC85277** Silver 390mm x 450mm x 100mm
- GPC85136** Black 250mm x 300mm x 60mm
- GPC85282** Black 390mm x 450mm x 100mm



Rope handled bags

Plain. Available in 100's.

- CB2** (gloss) / **CB6** (matt) Medium - 180mm(w) x 70mm(d) x 230mm
- CB3** (gloss) / **CB7** (matt) Large - 260mm(w) x 92mm(d) x 258mm

Available in black, navy blue, burgundy, dark green, silver and white with gloss / matt finish.



Grip seal bags

Available in many sizes, supplied in packs of 100, 500 & 1,000.

Size(mm)	Plain	White panelled
38 x 63	11124	11124P
57 x 75	11126	11126P
75 x 82	11127	11127P
89 x 114	11128	11128P
119 x 119	11129	11129P
102 x 140	11130	11130P
140 x 140	11131	11131P
76 x 191	11132	11132P
127 x 191	11133	11133P
191 x 191	11134	11134P
152 x 229	11135	11135P
203 x 280	11136	11136P
229 x 324	11137	11137P



Kraft paper carrier bags

Black, red or white, ribbed paper carrier bags, with a strong, twisted paper handles and a generous block base. Available in 50's.

- PC57528** Black paper carrier 180mm x 240mm x 80mm
- PC57529** Black paper carrier 220mm x 290mm x 100mm
- PC57532** Red paper carrier 180mm x 240mm x 80mm
- PC57533** Red paper carrier 220mm x 290mm x 100mm
- PC57520** White paper carrier 180mm x 240mm x 80mm
- PC57521** White paper carrier 220mm x 290mm x 100mm



DW1 A5 plastic wallets

Ideal for record cards. Sold in packs of 25.



ZS1 Zip seal high capacity wallet

Ideal for storing spectacle cases and record cards. Size approximately 190mm x 240mm x 30mm. Supplied in packs of 12.

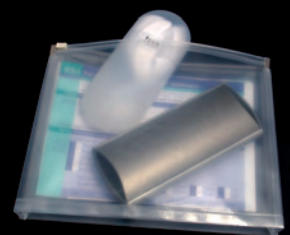

Header Labels for Frame Displays

These are printed to order to your designs. Printed onto sign grade gloss white vinyl with a permanent adhesive and cut to shape. Supplied to you ready to peel off and apply to your displays. Perfect for promotions, drawing attention to designer ranges, helping customers choose with price and special offers. Please supply your wording, label shape and size, background colour and text colour.

Prices depend on size, quantity and number of designs required. Please contact us for a price.

Hint: Prepare a sketch on a piece of paper with all the details shown, photograph it using your phone and email it to us at sales@ewmorris.co.uk. We will prepare a mock up and email it back for your approval before printing.



High Impact Sale Material

A frames

A stylish design in durable anodised finish with a clip close frame for quick and easy loading. Includes a clear plastic poster protector. Water drainage holes at the base of the frame help to keep contents dry and keep maintenance to a minimum. Frame may need securing in high winds.

80999 - A1 to fit poster size 594mm x 841mm

83084 - A2 to fit poster size 420mm x 594mm

83087 - Double Crown to fit poster size 510mm x 760mm

A frame posters

A range of white on red posters to suit the A frames

Please note: suffix specifies which A Frame the poster fits.

AFPS...A1 - 594mm x 814mm poster to fit **80999**

AFPS...A2 - 420mm x 594mm poster to fit **83084**

AFPS...DC - 510mm x 760mm poster to fit **83087**

Bespoke wordings and designs undertaken.
Price on application.



High Impact Sale Material continued



A4 illuminated display

Illuminate your special offers with this fantastic A4 led lit contemporary display.

305mm x 265mm x 160mm max. Mains powered with supplied transformer. **CTLPA4P**

A4BLP - A4 back lit plain paper for illuminated display. Sold in packs of 5 sheets or choose from our range of back lit posters below.



SBA401-SBA408
Window banners



SCA401 - SCA408
Sale cards

Window banners & sale cards

Window banners are A4 finished size and have a 10mm transparent border. Sale cards are A4 finished size to suit our A4 card holder (**82984**)



Style 1



Style 2



Style 3



Style 4



Style 5



Style 6



Style 7



Style 8



Style BF

Style	A1 frame poster	A2 frame poster	DC frame poster	A4 backlist poster	A4 window poster	A4 sale card
	£37.50 each	£28.50 each	£32.50 each	£11.00 each	£5.50 each	£2.75 each
1	AFPS001A1	AFPS001A2	AFPS001DC	A4BL01	SBA401	SCA401
2	AFPS002A1	AFPS002A2	AFPS002DC	A4BL02	SBA402	SCA402
3	AFPS003A1	AFPS003A2	AFPS003DC	A4BL03	SBA403	SCA403
4	AFPS004A1	AFPS004A2	AFPS004DC	A4BL04	SBA404	SCA404
5	AFPS005A1	AFPS005A2	AFPS005DC	A4BL05	SBA405	SCA405
6	AFPS006A1	AFPS006A2	AFPS006DC	A4BL06	SBA406	SCA406
7	AFPS007A1	AFPS007A2	AFPS007DC	A4BL07	SBA407	SCA407
8	AFPS008A1	AFPS008A2	AFPS008DC	A4BL08	SBA408	SCA408
BF	BF003	BF002	-	-	-	BF001

Card holders

82984 A4 Portrait

82985 A5 Portrait

82988 A5 Landscape

82989 A6 Landscape

82986 A6 Portrait

82990 A8 Landscape

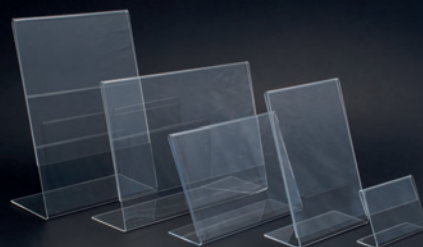

Sale Banners

Printed onto self cling window material, leaves no adhesive residue when removed.
Each banner measures 95mm x 975mm unless indicated.

SALE SALE SALE SALE

SCB01

SALE NOW ON

SCB02

SALE ENDING SOON

SCB03

SALE ENDS TODAY

SCB04

SALE MUST END SOON

SCB05

FLASH SALE TODAY ONLY

SCB06

COMPARE OUR PRICES

SCB07

GENUINE DISCOUNTS

SCB08

FINAL REDUCTIONS

SCB09

MASSIVE CLEARANCE SALE

SCB10

DESIGNER FRAMES SALE

SCB27

FREE SECOND PAIR OFFERS

SCB28

PRESCRIPTION SUNGLASSES

SCB31

25% OFF MARKED PRICES

SCB11

50% OFF MARKED PRICES

SCB12

NEW YEAR SALE NOW ON

SCB13

MID SEASON SALE

SCB14

SPRING SALE NOW ON

SCB15

SUMMER SALE NOW ON

SCB16

AUTUMN SALE NOW ON

SCB17

WINTER SALE NOW ON

SCB18

END OF SEASON SALE

SCB19

BLACK FRIDAY SALE

SCB20

FABULOUS FRAME OFFERS

SCB29

GREAT STUDENT OFFERS

SCB30

OFFERS FOR OLDER ADULTS

SCB32

**S
A
L
E
S
A
L
E
S
A
L
E**

SCB21

SALE

SCB22 (700mm x 250mm) white on red

SALE

SCB24 (700mm x 250mm) red on clear

SALE

SCB23 (700mm x 250mm) red on white

SALE NOW ON
SCB25 (700mm x 700mm x 990mm)
SALE NOW ON
SCB26 (700mm x 700mm x 990mm)

Display Accessories

FD1 Acrylic frame display

Holds one pair of spectacles. 80mm diameter.
Available in a wide range of colours, please see online.

Solid gloss colours - black, white, red, orange, light blue, royal blue, yellow and green.
Translucent colours - gloss clear, red, green and royal blue.
Frosted - clear, yellow, orange, pink, plum, grey and royal blue.
Matt solid colours - cool grey, mauve, dark grey, black, denim blue and white.
Pastel Colours - spearmint green, palma violet, orange fizz, bubblegum blue and sour grape.
Fluorescents - acid green, lava orange, helios yellow and mars red.
Wooden version - 3mm birch ply.



FD7 Acrylic frame stand

Holds 3 pairs of spectacle frames.
Available in the same colour range as our FD1. Front panel is clear but other colours can be supplied on request.
250mm (h) x 160mm (w) x 120mm (d).



FD9 Acrylic display for 3 pairs of spectacle frames

Made to order from 3mm thick acrylic and available in a range of colours.
Please see our web shop for options. 180mm x 240mm x 115mm.
Supplied flat for easy assembly.



FD5 Acrylic display for 5 pairs of spectacle frames

Made to order from 3mm thick acrylic and available in a range of colours.
Please see our web shop for options. 380mm x 190mm x 250mm.



Flat display panels - FDP

Eye catching display panels in a large range of colours including mirror finish silver, gold and rose gold. 180mm x 80mm x 3mm. We can cut other sizes if required, please contact us with your size details.

Available with or without clear feet.



Display Accessories

Fluorescent bridge pedestals

Eye catching bridge pedestals in acid green and lava orange. The edges appear to be illuminated in most lighting conditions.



190mm x 120mm x 35mm

AGA101 acid green
LOA101 lava orange

The Nose

Display unit ideal for window and cabinet displays. The unit is made of three easy to assemble parts - a base, a stand and the nose. Frames can be displayed with open or closed arms.



Available in 6 colours, crystal clear (**NOS/C**), gloss white (**NOS/W**), gloss black (**NOS/B**), gloss red (**NOS/R**), satin brown (**NOS/BR**), and satin grey (**NOS/G**).

Acrylic display cubes

Please refer to website for current pricing and availability.



FST Frame stand 'tree'

Holds up to 4 pairs of spectacle frames. Ideal for showing off frame arms. Height 310mm, base 150mm diameter, width 370mm (max), support wires 180mm.

Supplied flat ready for easy assembly.



MT-6 Frame stand

Holds 6 pairs of spectacle frames. Base plate made of silver-coloured plated steel, with one single rod.

Requires assembly.

530mm (h)
x 210mm (w)
x 210mm (d).

FD3 Acrylic and wire frame display for single pair of spectacles

Available with white, black, red, blue or orange base.



FD4 Wire frame display with stainless steel base

For a single pair of spectacles.



FD6 Wire frame display with stainless steel counterweight

For single pair of spectacles.



TS2 Acrylic step

Available in clear, gloss black and mirror finish. (Mirror on display side only).

200mm (H)
x 240mm (W)
x 200mm (D)



TS2A Acrylic step

Available in clear only.
100mm (H)
x 100mm (W)
x 200mm (D)



TS3 Acrylic step

Available in clear and gloss black.
190mm (H)
x 170mm (W)
x 240mm (D)



Square acrylic blocks

AB01 50mm x 50mm x 20mm (D)
AB02 50mm x 50mm x 40mm (D)
AB03 75mm x 75mm x 20mm (D)
AB04 75mm x 75mm x 40mm (D)
AB05 100mm x 100mm x 20mm (D)
AB06 100mm x 100mm x 40mm (D)



Solar turntables

Please refer to website for current pricing and availability.
Turntable 100mm diameter. Available in black, white, gold or silver (max. capacity 500g)



TBSOLARWH white



TBSOLARBK black



TBSOLARSI silver



TBSOLARGD gold

Bridge pedestals

82972 - 3mm acrylic
90mm x 60mm x 60mm
82974 - 3mm acrylic
150mm x 100mm x 100mm
82976 - 5mm acrylic
225mm x 150mm x 150mm
82978 - 5mm acrylic
300mm x 200mm x 200mm



Leaflet holders

1101 DL portrait
1102 A5 portrait
1103 A4 portrait
1104 DL portrait 4 tier



Card holders

82984 A4 Portrait
82985 A5 Portrait
82988 A5 Landscape
82989 A6 Landscape
82986 A6 Portrait
82990 A8 Landscape

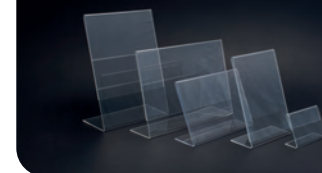

Mirrored turntables

Battery not included
88432 125mm diameter



Mirrors

Contemporary counter/table top mirror.
160mm x 280mm x 160mm.

MIR/W White **MIR/B** Black



Business card holders

82979 single tier
83089 4 tier



Miscellaneous Items

Paper address labels (40mm x 20mm)

Promote your company at every opportunity. Suitable for solution bottles, spectacle cases, stationery etc.



Available black text on white, yellow, cream, silver, green, blue, red, clear, radiant red, or radiant yellow. Other specifications available, please contact us.

Display cards

ALL PRICES INCLUDE SINGLE VISION LENSES
Packs of 5.

AP1 - 80mm x 55mm

AP2 - 230mm x 45mm



Other wordings available to order - please contact us for details.

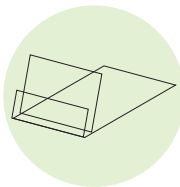

ACH001
Small acrylic card holders

Job trays

Stackable Rx trays, 151mm x 226mm x 36mm. Supplied in cases of 24 trays of the same colour. Six colours available.

- JT001 Red
- JT002 Blue
- JT003 Black
- JT004 Yellow
- JT005 Green
- JT006 White



CSBL - Cleaning solution bottle labels

Full colour bespoke designs undertaken for your bottles. Minimum quantity 1,000. Please contact us for pricing.



Block out labels

Designed to block out product part numbers on spectacles. Available in two sizes and two colours (white or black) from stock. Supplied in dispenser boxes of 1,000 labels. Bespoke sizes available on request.

- BL14W/BL14B - 14mm x 4mm
- BL20W/BL20B - 20mm x 4mm

Other sizes and colours produced to order, please contact us.



EYEP001 Eye patch

Made of soft black vinyl with irritation-free lining.



Recycled glass head

GDH01 Unisex, green tint glass, 290mm high.



6014BF Black plastic tray

With black foam insert. 370mm x 205mm x 37mm.



Display heads

Polystyrene heads, lightweight and non-slip base.

- 86086 Male, black flocked 320mm high.
- 86088 Female, black flocked 330mm high.
- 85995 Male, white polystyrene 320mm high.
- 85994 Female, white polystyrene 330mm high.



Signage



ATS1-150G/S
ATS1-200G/S



ATS2-150G/S
ATS2-200G/S



ATS3-150G/S
ATS3-200G/S



ATS4-150G/S
ATS4-200G/S

Mirror acrylic signs on clear acrylic with metallic stand offs. Standard colours are mirror gold or mirror silver. Available in 150mm or 200mm diameter.

A full bespoke acrylic sign service is available for signage up to 1200mm x 800mm. Please call us.

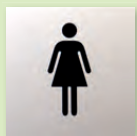

Female
41972

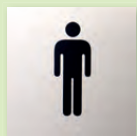

Male
41973



Disabled
41974

Premier aluminium signs. Smart, contemporary, self adhesive signs made from anodised aluminium with strong black graphics.

Easy to apply to any clean surface. 160mm x 40mm and 80mm x 80mm.

We can personalise any aluminium size with your own wording.

Examples of bespoke acrylic signs



41970 PULL
Self adhesive anodised aluminium

41971 PUSH
Self adhesive anodised aluminium

2771046 No smoking
150mm x 200mm
Self adhesive vinyl

41964 CCTV
150mm x 200mm
Self adhesive vinyl

2771045 No smoking
150mm x 150mm
Self adhesive vinyl

SR71733 Fire exit Keep clear
450mm x 150mm
Self adhesive vinyl

41969 PRIVATE
Self adhesive anodised aluminium

SLD001 In/Out slider
156mm x 42mm
Aluminium with adhesive backing

85560 OPEN/CLOSED door sign
with cord and fixing
250mm x 70mm

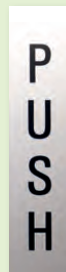
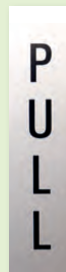

Door nameplate holders. Metal door holders with door plates are supplied with screws, self adhesive tape or velcro.

DP1 Door plate with name
DP2 Replacement names

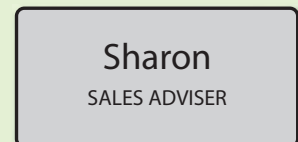

NB1 Name badges.
Standard badges are silver with black printed lettering and a pin fixing on the reverse. Standard size 60mm x 30mm.

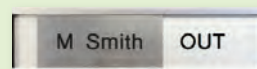
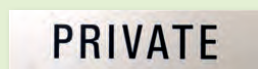

Other colours and shapes can be produced to order. Badges can have dome finish and magnetic fixing as extras.

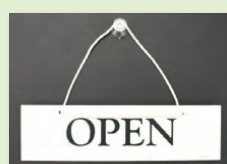

Order via email to sales@ewmorris.co.uk
or online at www.ewmorris.co.uk

Existing customers with account facilities can register online and then email to request an online account facility to allow online ordering with your 30 day credit account.

Ordering tip: If ordering price tickets use your phone to photograph your list and email it to us.

T: 01235 543993 • E: sales@ewmorris.co.uk
E.W. MORRIS (OXFORD), 3 ISIS COURT, WYNDYKE FURLONG,
ABINGDON BUSINESS PARK, ABINGDON, OXFORDSHIRE. OX14 1DZ

INTERNATIONAL TEL: +44 1235 543993
E.W. Morris is a trading name of Listan Publications Limited.